

Application Guidelines

Sources of EMI

Electromagnetic interference occurs naturally from terrestrial sources such as lightning discharges, precipitation, and sand and dust storms, in addition to cosmic noise emanating from sources within and outside our solar system. Man-made sources include power lines, rotating machinery, ignition systems, television and radio receivers, fluorescent lights, power amplifiers, computing devices and transmitters of all types.

Interference Suppression

Filter networks suppress electromagnetic interference in two basic ways. The capacitor elements shunt the interference to ground, and the series inductor elements raise the impedance of the line making the shunt capacitor elements even more effective.

Capacitor Elements

The types of capacitors used in Spectrum Control filters are often referred to as feed-through capacitors due to their physical geometry.

The feed-through design results in greatly reduced self-inductance compared to standard leaded capacitors. Also, this design effectively prevents radiation from the input coupling directly with the output of the capacitor, unlike leaded or chip capacitors. The combination of low inductance and high input/output isolation provides excellent shunting of EMI for frequencies up to and beyond 1 GHz.

The simplest feed-through type is a ceramic tube that may have buried electrodes and can be constructed as a single capacitor or as two capacitors, as used in a Pi section filter. This type of device can have capacitance values from 10 pF to 0.1 μ F and typical working voltage ratings up to 2500 VDC. Due to the simple construction, these capacitors are very efficient at frequencies up to 10 GHz and exhibit no pronounced resonances.

Multilayer monolithic discoidal capacitors are used for very high capacitance parts in standard sizes or for smaller filters where the required capacitance cannot be achieved by a ceramic tube. This type of capacitor consists of alternate layers of opposite polarity electrodes separated by a ceramic dielectric. Typical capacitance values from 100 pF to 10 μ F are available with working voltages up to 400 VDC.

Inductive Elements

Ferrite sleeves are used with tubular capacitors since they can be conveniently accommodated inside the tube to provide a very compact filter. They are also used with discoidal capacitors in some applications. Wound inductors are used with discoidal capacitors to provide very high performance filters.

Multilayer Discoidal Capacitor

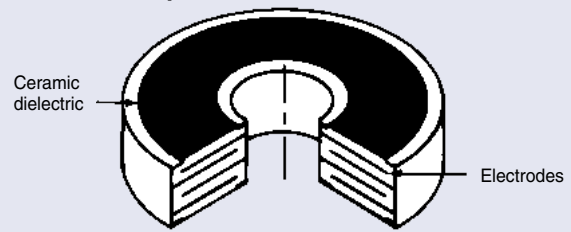

Embedded Electrode Tubular Capacitor

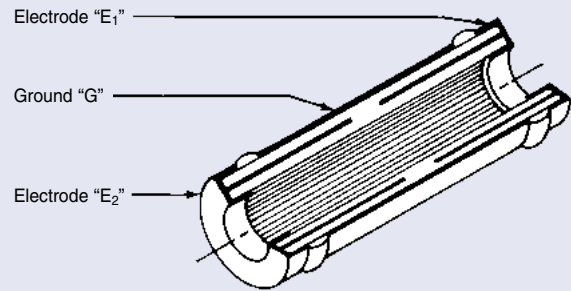

Resin Sealed Filter

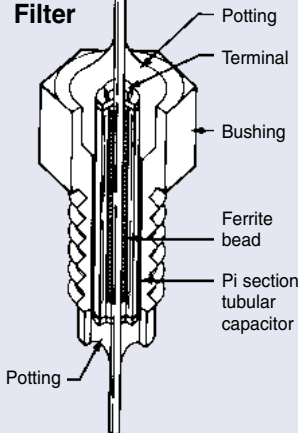

Hermetically Sealed Filter

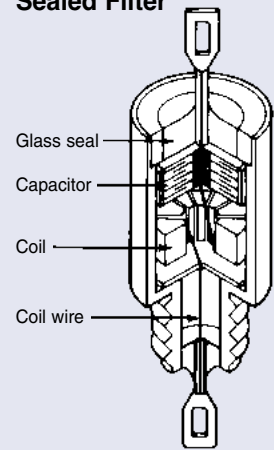

Circular Filtered Connector

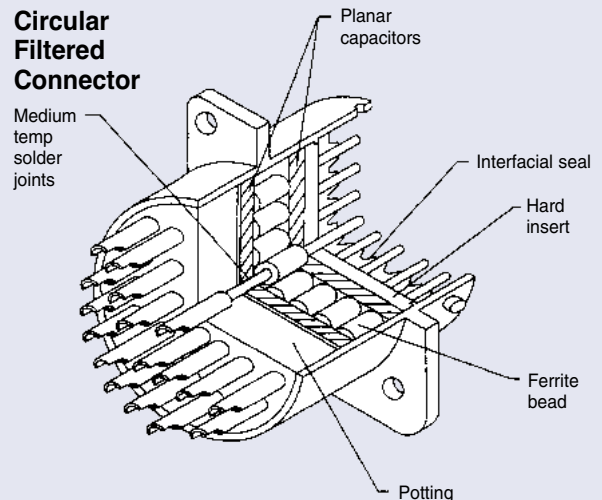

Application Guidelines

Low Pass EMI filters are available in the following circuit configurations:

C Filter

The C filter is a three terminal feed-through capacitor. It is used to attenuate high frequency signals.

L Filter

An L filter consists of one inductive element and one capacitive element. This type of filter can offer high impedance or low impedance input depending upon its orientation in the circuit. It is most commonly used in applications where one has a high impedance load and a low impedance source (see LT), or where one has a high impedance source and a low impedance load (see LB).

Pi Filter

The Pi filter contains two capacitive elements and one inductive element. It presents a low impedance to both the source and the load. Because of the additional element, it provides better high frequency performance than the C or L configurations. Due to the possibility of 'ringing', Pi filters are not recommended for switching applications.

Transient Suppression Pi Filter

The transient suppression Pi filter consists of a Pi filter with a transient suppressor at the input to the filter. The filter supplies the high frequency performance of the Pi filter with the added protection of the transient suppressor to protect the circuit from voltage spikes on the line.

T Filter

The T filter consists of two inductive elements and one capacitive element. This circuit configuration presents a high impedance input from either end. It has similar filter performance to the Pi circuit configurations. It does not have the ringing characteristic of the Pi filter and can be used in switching applications.

Multisection Filter (Double T)

Spectrum Control's multielement filters are designed for optimum insertion loss in circuits with a relatively low source and load impedance. These filters are also recommended in any application where a high degree of filtering is required. The unit utilizes an inductor input for the best compatibility with a MIL-STD-461 test setup (10 μ F feed-through capacitor).

Schematics

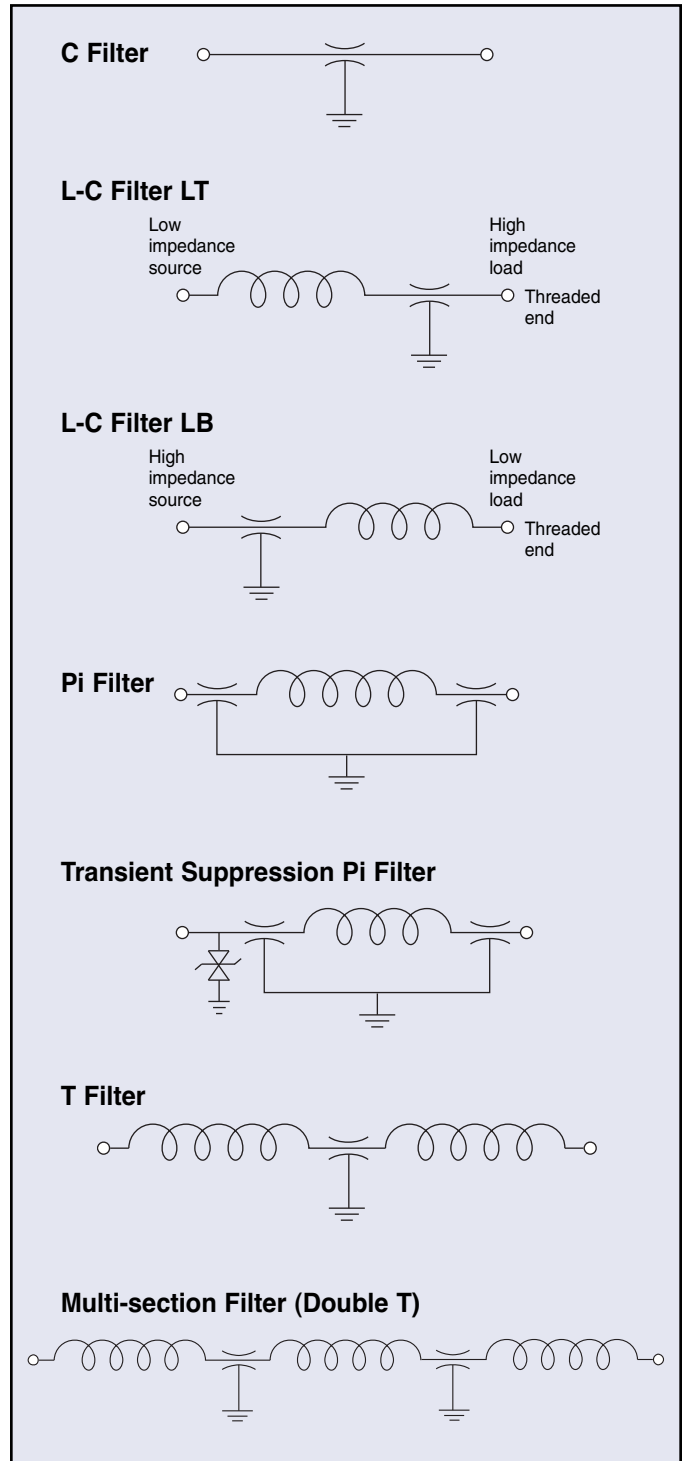

Application Guidelines

Insertion Loss Measurement

Insertion loss (IL) is a measure of the effectiveness of a filter. It is defined as the ratio of the voltage (E1) across the circuit load without the filter and the voltage (E2) across the load with the filter. Since insertion loss is dependent on the source and load impedance in which the filter is to be used, IL measurements are defined for a matched 50 ohm system. The insertion loss is measured in decibels (dB) and defined as follows:

$$IL \text{ (dB)} = 20 \log \left[\frac{E1}{E2} \right]$$

Circuit Impedance vs. Insertion Loss

In practical circuit applications the source and load impedances may be quite different from 50 ohms. If these impedances are known, our engineering team can provide information on the expected insertion loss or an estimate can be made using the following formula:

$$IL \text{ (dB)} = 20 \log \left[1 + \frac{Z_s Z_l}{Z_t (Z_s + Z_l)} \right]$$

Where Z_s = Source impedance in ohms
 Z_l = Load impedance in ohms
 Z_t = Transfer impedance in 50 ohm system

Example:

1. System source and load impedances are 100 ohms and 600 ohms respectively.
2. Selected filter has insertion loss of 50 dB at 100 MHz in a 50 ohm system.
3. From the IL vs Transfer Impedance curve (right) the transfer impedance is 0.08 ohms.

$$\begin{aligned}
 4. \quad IL &= 20 \log \left[1 + \frac{100 \times 600}{0.08 (100+600)} \right] \\
 &= 20 \log 1072 \\
 &= 61 \text{ dB}
 \end{aligned}$$

Insertion Loss (dB)

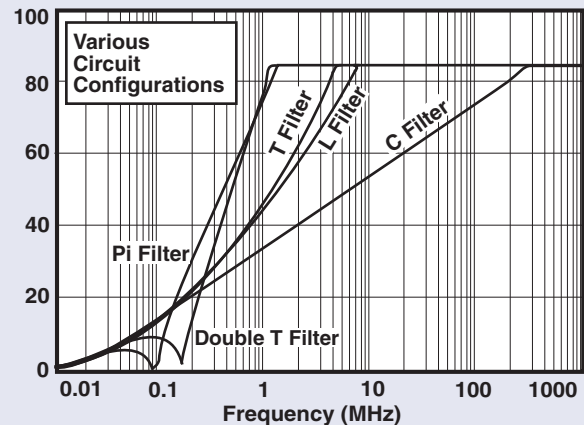
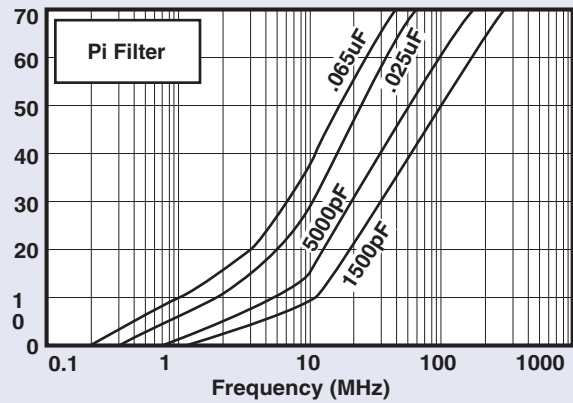
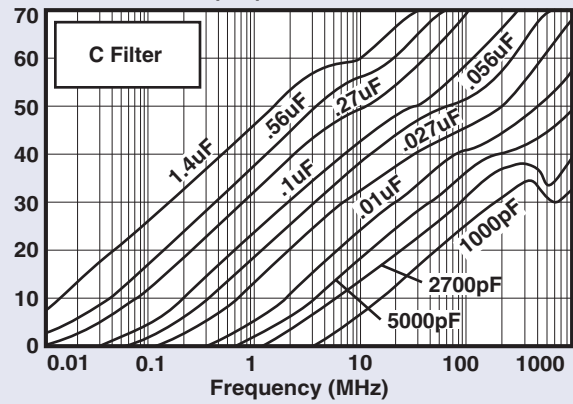

Transfer Impedance Graph

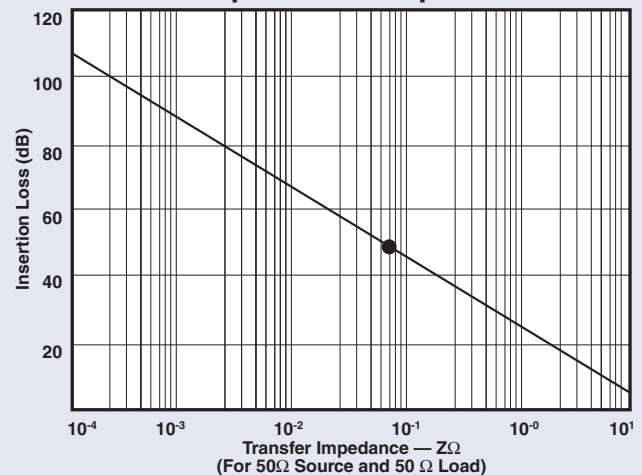

Hermetically Sealed Threaded Case Filters

This series of filters features hermetic glass seals and high EMI filtering performance. They are excellent for critical applications that demand high reliability in the toughest environmental conditions and provide broad-band high performance EMI filtering from 10 KHz to over 10 GHz.

Features

- MIL-F-15733 and MIL-F-28861, DSCC 84084 QPL filters available
- Popular .375", .410" and .690" case diameters
- Voltage ratings from 50 V to 400 VDC/240 AC, 400 Hz
- Impervious to high moisture environments, solvents and severe environmental conditions
- High temperature terminal construction
- D-slotted bushings
- High reliability testing available



Thread length: A - 0.187 (4.76) B - 0.312 (7.92)

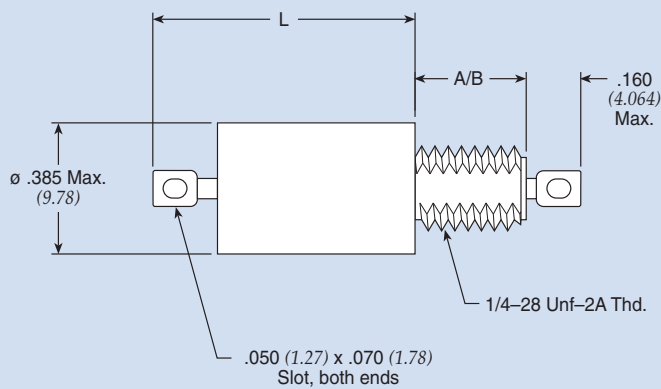

Figure 1

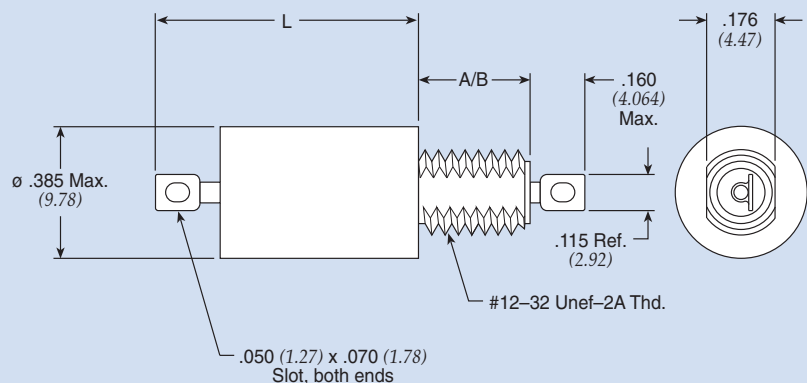

Figure 2

Dimensions in inches (mm)

Note: ø .410 Max. for M28861 parts

Hermetically Sealed Threaded Case Filters

.375 ø C Circuit Standard

Part Number	MIL No	See Pg. LP26 for Fig.	Rated Voltage				I Amp	Min Cap µF	DCR Max Ohms	Max L		Thd Lgth	Minimum Insertion Loss (dB)						
			85°C		125°C					In	(mm)		30 KHz	150 KHz	300 KHz	1 MHz	10 MHz	100 MHz	1 GHz
			DC	AC	DC	AC													
+ 54-367-008	—	1	80	—	50	—	15	1.400	0.005	0.387	(9.830)	A	15	28	33	44	60	70	70
54-370-007	—	1	80	—	50	—	15	2.800	0.005	0.576	(14.630)	A	20	34	39	50	60	70	70
54-371-001	—	1	80	—	50	—	15	4.000	0.005	0.688	(17.475)	A	26	40	46	55	60	70	70
54-367-005	—	1	150	—	100	—	15	0.450	0.005	0.387	(9.830)	A	6	19	25	36	55	70	70
+ 9920-100-6002	—	1	200	—	150	125	15	0.150	0.005	0.387	(9.830)	A	—	6	15	26	42	55	70
54-367-007	—	1	250	—	200	125	15	0.015	0.005	0.387	(9.830)	A	—	—	—	6	25	45	50
+ 54-367-006	—	1	250	—	200	125	15	0.250	0.005	0.387	(9.830)	A	—	14	19	30	50	65	70
54-370-006	—	1	250	—	200	125	15	0.500	0.005	0.630	(16.002)	A	7	20	28	39	55	70	70
9923-100-6004	—	1	400	—	400	240	15	0.060	0.005	0.415	(10.541)	A	—	5	10	18	38	55	70

.375 ø C Circuit MIL Qualified (See MIL index on pages CF9-11 for complete MIL part number listing)

Part Number	M15733 M28861Ø MIL No	See Pg. LP26 for Fig.	Rated Voltage				I Amp	Min Cap µF	DCR Max Ohms	Max L		Thd Lgth	Minimum Insertion Loss (dB)						
			85°C		125°C					In	(mm)		30 KHz	150 KHz	300 KHz	1 MHz	10 MHz	100 MHz	1 GHz
			DC	AC	DC	AC													
54-367-054	1-012Ø	1	—	—	50	—	15	1.200	0.008	0.410	(10.414)	B	15	28	33	40	40	70	70
54-367-049	1-002Ø	1	—	—	50	—	15	1.200	0.008	0.410	(10.414)	A	15	28	33	40	40	70	70
54-370-032	49-0008	1	—	—	50	—	15	2.100	0.010	0.576	(14.630)	A	20	33	40	50	65	70	70
54-367-055	1-014Ø	1	—	—	70	—	15	0.700	0.008	0.410	(10.414)	B	10	24	30	40	40	64	70
54-370-030	34-0035	2	—	—	100	—	10	0.300	0.004	0.474	(12.040)	A	7	19	25	35	55	70	70
54-367-051	1-006Ø	1	—	—	100	—	15	0.450	0.008	0.410	(10.414)	A	6	19	25	36	40	60	70
54-367-056	1-016Ø	1	—	—	100	—	15	0.450	0.008	0.410	(10.414)	B	6	19	25	36	40	60	70
54-367-057	1-018Ø	1	—	—	150	—	15	0.250	0.008	0.410	(10.414)	B	—	14	20	31	40	56	70
54-367-053	1-010Ø	1	—	—	200	125	15	0.150	0.008	0.410	(10.414)	A	—	10	16	26	40	52	70
54-367-058	1-020Ø	1	—	—	200	125	15	0.150	0.008	0.410	(10.414)	B	—	10	16	26	40	52	70
54-370-034	49-0010	1	—	—	330	—	15	0.062	0.004	0.680	(17.272)	A	—	2	7	17	37	55	70

+ Also available through authorized distributors.

Hermetically Sealed Threaded Case Filters

.375 ø L Circuit

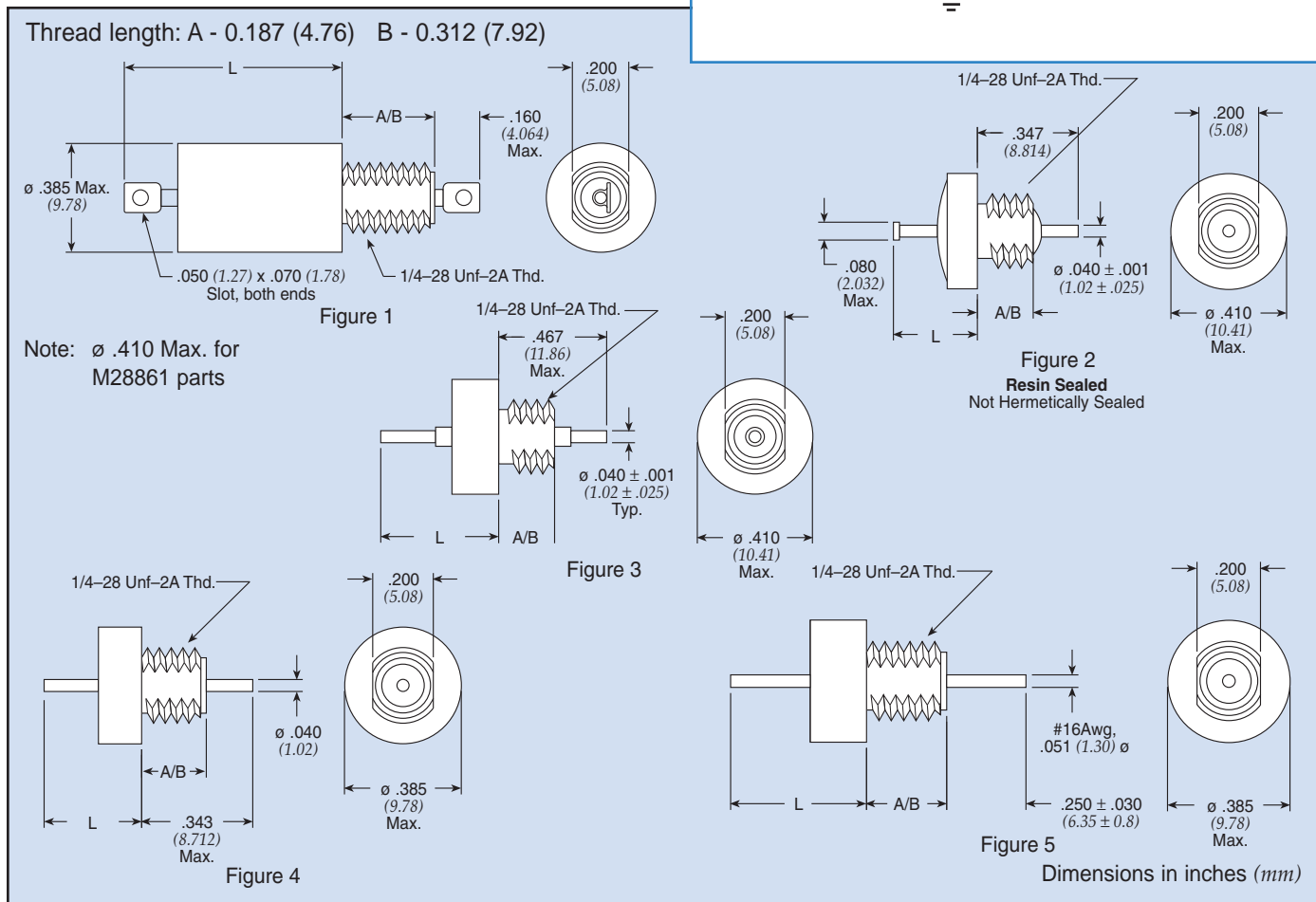

L-C Filter LT

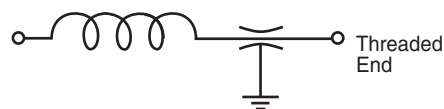

L-C Filter LB



.375 ø L Standard Low Profile

Part Number	MIL No	Figure	Rated Voltage				I Amp	Min Cap µF	DCR Max Ohms	CKT	Max L In	Max L (mm)	Thd Lgth	Minimum Insertion Loss (dB)						
			85°C DC	85°C AC	125°C DC	125°C AC								30 KHz	150 KHz	300 KHz	1 MHz	10 MHz	100 MHz	1 GHz
† 9051-100-0000	—	1	80	—	50	—	15	1.200	0.005	LB	0.370	(9.398)	A	15	25	34	44	60	70	70
† 51-359-001 €	—	1	80	—	50	—	15	1.400	0.005	LB	0.370	(9.398)	A	15	28	33	44	60	70	70
SCI-1021-000	—	2*	80	—	50	—	15	1.400	0.003	LB	0.280	(7.112)	A	15	28	33	44	60	70	70
† 9053-100-0001	—	1	80	—	50	—	15	1.400	0.005	LB	0.370	(9.398)	A	15	25	34	44	60	70	70
† 51-717-001 €	—	2*	80	—	50	—	15	1.400	0.005	LB	0.325	(8.255)	A	15	28	33	44	60	70	70
51-344-006	—	4	80	—	50	—	15	1.400	0.005	LB	0.330	(8.382)	A	15	28	33	44	60	70	70
† SCI-1020-000	—	1	80	—	50	—	15	1.400	0.003	LB	0.370	(9.398)	A	15	28	33	44	60	70	70
SCI-1021-020	—	2 ^o *	80	—	50	—	15	1.400	0.003	LB	0.280	(7.112)	B	15	28	33	44	60	70	70
† SCI-1020-020	—	1	80	—	50	—	15	1.400	0.003	LB	0.370	(9.398)	B	15	28	33	44	60	70	70
SCI-1150-001	—	1	80	—	50	—	15	2.800	0.003	LB	0.450	(11.430)	B	20	34	40	49	60	70	70
9051-101-0018	—	5	80	—	50	—	25	1.400	0.001	LB	0.450	(11.430)	A	15	25	34	44	60	70	70
† 9053-100-0008	—	1	100	—	70	—	15	0.700	0.005	LB	0.370	(9.398)	A	9	20	29	39	52	70	70

* Part is resin sealed, this is not a hermetic part.

† Also available through authorized distributors.

€ Also available through authorized European distributors/agents.

◇ Note: 0.462" (11.73mm) length from mounting surface to end of lead — not 0.347" (8.8mm).

Hermetically Sealed Threaded Case Filters

L-C Filter LT

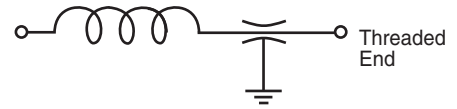

L-C Filter LB

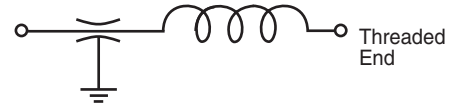

.375 ø L Standard Low Profile *continued*

Part Number	MIL No	See Pg. LP28 for Fig	Rated Voltage				I Amp	Min Cap µF	DCR Max Ohms	CKT	Max L		Thd Lgth	Minimum Insertion Loss (dB)							
			85°C		125°C						In	(mm)		30 KHz	150 KHz	300 KHz	1 MHz	10 MHz	100 MHz	1 GHz	
			DC	AC	DC	AC															
† 9050-100-0008	—	2*	100	—	70	—	15	0.750	0.005	LB	0.325	(8.255)	A	9	20	29	39	52	70	70	
† 9053-100-0002	—	1	150	—	100	—	15	0.500	0.005	LB	0.370	(9.398)	A	4	12	21	31	48	70	70	
SCI-1250-001	—	1	150	—	100	—	15	0.500	0.003	LB	0.450	(11.430)	B	8	20	25	34	50	64	70	
€ SCI-2150-000	—	1	150	—	100	—	15	1.000	0.003	LB	0.450	(11.430)	A	10	25	30	41	56	70	70	
SCI-2150-001	—	1	150	—	100	—	15	1.000	0.003	LB	0.450	(11.430)	B	10	25	30	41	56	70	70	
† 51-717-007	—	2*	250	125	200	125	15	0.015	0.005	LB	0.325	(8.255)	A	—	—	—	6	25	38	45	
† 51-359-007	—	1	250	125	200	125	15	0.012	0.005	LB	0.370	(9.398)	A	—	—	—	6	25	38	50	
9050-100-0011	—	2	350	125	300	125	15	0.150	0.008	LB	0.325	(8.255)	A	—	10	15	25	40	52	60	
€ SCI-2350-000	—	1	300	125	300	125	15	0.250	0.003	LB	0.450	(11.430)	A	4	15	21	31	50	70	70	
SCI-2350-001	—	1	300	125	300	125	15	0.250	0.003	LB	0.450	(11.430)	B	4	15	21	31	50	70	70	

* Part is resin sealed, this is not a hermetic part.

(See MIL index on pages CF9-11 for complete MIL part number listing)

.375 ø L Circuit MIL Qualified Low Profile

Part Number	M15733 M28861 MIL No	See Pg. LP28 for Fig	Rated Voltage				I Amp	Min Cap µF	DCR Max Ohms	CKT	Max L		Thd Lgth	Minimum Insertion Loss (dB)							
			85°C		125°C						In	(mm)		30 KHz	150 KHz	300 KHz	1 MHz	10 MHz	100 MHz	1 GHz	
			DC	AC	DC	AC															
† 51-359-021	38-0004	1	—	—	50	—	10	1.400	0.008	LB	0.370	(9.398)	A	15	28	33	44	60	70	70	
† 51-359-024	38-0005	1	80	—	50	—	10	1.400	0.008	LB	0.370	(9.398)	A	15	28	33	44	60	70	70	
† 51-359-051	58-0001	1	80	—	50	—	10	1.400	0.008	LB	0.545	(13.843)	A	15	28	33	44	60	70	70	
51-359-105	58-0004	1	80	—	50	—	10	1.400	0.008	LT	0.545	(13.843)	B	15	28	33	44	60	70	70	
† 51-359-044	49-0006	1	100	—	50	—	15	1.200	0.010	LB	0.370	(9.398)	A	15	28	33	44	60	70	70	
† 51-359-055	49-0007	3	100	—	50	—	15	1.200	0.010	LB	0.450	(11.43)	A	15	28	33	44	60	70	70	
51-359-081	1-001◇	1	—	—	50	—	15	1.400	0.008	LB	0.410	(10.414)	A	15	28	33	40	40	70	70	
51-359-086	1-011◇	1	—	—	50	—	15	1.400	0.008	LB	0.410	(10.414)	B	15	28	33	40	40	70	70	
† 51-359-053	49-0001	4	100	—	50	—	15	0.680	0.010	LB	0.319	(8.103)	A	8	20	28	38	55	70	70	
51-359-082	1-003◇	1	—	—	70	—	15	0.700	0.008	LB	0.410	(10.414)	A	10	24	30	40	40	64	70	
51-359-083	1-005◇	1	—	—	100	—	15	0.450	0.008	LB	0.410	(10.414)	A	6	19	25	36	40	60	70	
51-359-088	1-015◇	1	—	—	100	—	15	0.450	0.008	LB	0.410	(10.414)	B	6	19	25	36	40	60	70	
51-359-084	1-007◇	1	—	—	150	—	15	0.250	0.008	LB	0.410	(10.414)	A	—	14	20	31	40	56	70	
51-359-050	38-0008	1	—	—	200	125	15	0.150	0.008	LB	0.370	(9.398)	A	—	—	—	6	25	42	60	
51-359-085	1-009◇	1	—	—	200	125	15	0.150	0.008	LB	0.410	(10.414)	A	—	10	16	26	40	52	70	
51-359-090	1-019◇	1	—	—	200	125	15	0.150	0.008	LB	0.410	(10.414)	B	—	10	16	26	40	52	70	

† Also available through authorized distributors.

€ Also available through authorized European distributors/agents.

Hermetically Sealed Threaded Case Filters

.375 ø L Circuit

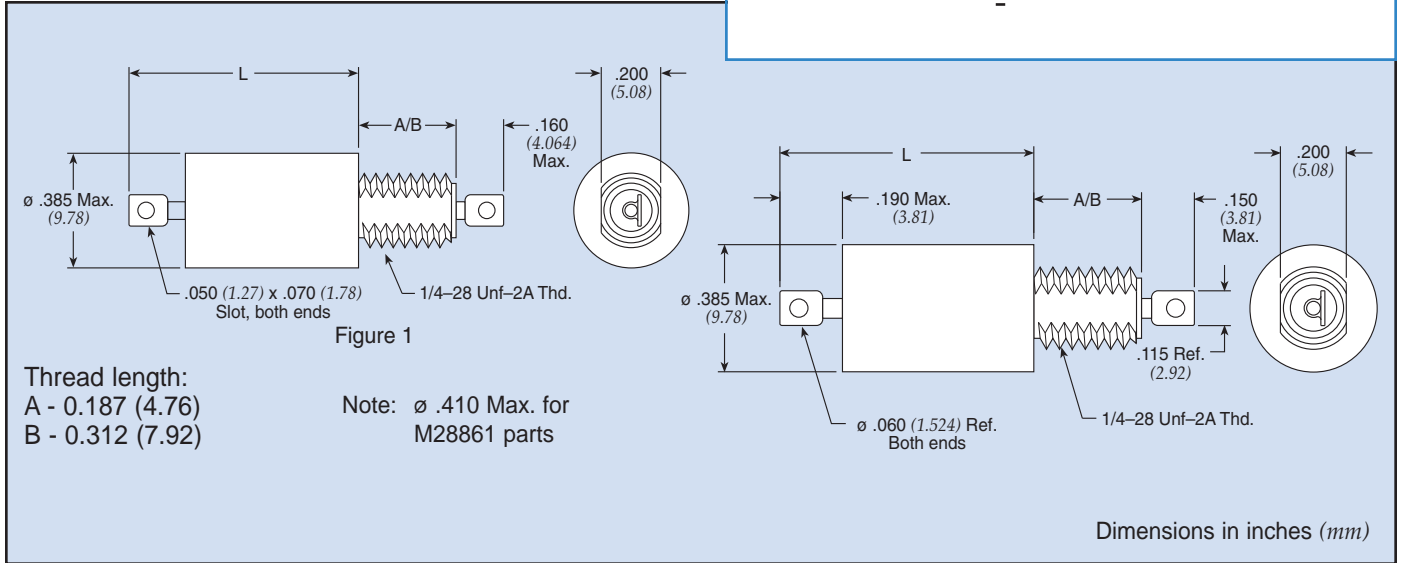

.375 ø L Circuit Standard Product

Part Number	MIL No	Figure	Rated Voltage				I Amp	Min Cap µF	DCR Max Ohms	CKT	Max L In	Max L (mm)	Thd Lgth	Minimum Insertion Loss (dB)						
			85°C		125°C									30 KHz	150 KHz	300 KHz	1 MHz	10 MHz	100 MHz	1 GHz
			DC	AC	DC	AC														
51-353-007	—	1	80	—	50	—	0.06	1.400	70.000	LB	0.770	(19.558)	A	44	70	70	70	70	70	70
51-353-095	—	1	80	—	50	—	0.15	1.400	12.000	LT	0.960	(24.384)	A	21	52	64	70	70	70	70
51-353-003	—	1	80	—	50	—	0.45	1.400	1.200	LB	0.770	(19.558)	A	16	31	37	55	70	70	70
51-353-099	—	1	80	—	50	—	1.00	1.400	0.250	LT	0.770	(19.558)	A	16	33	44	70	70	70	70
51-353-100	—	1	80	—	50	—	5.00	1.400	0.015	LT	0.770	(19.558)	A	15	28	33	46	70	70	70
† 9200-300-0025	—	1	80	—	50	—	10.00	1.200	0.010	LB	0.450	(11.430)	A	15	28	33	44	60	70	70

† Also available through authorized distributors.

Hermetically Sealed Threaded Case Filters

L-C Filter LT

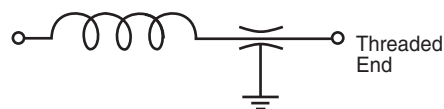

L-C Filter LB

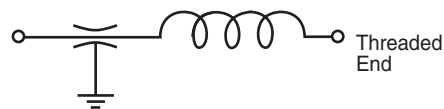

.375 ø L Circuit Standard Product *continued*

Part Number	See Pg. MIL LP30 for Fig	Rated Voltage				I Amp	Min Cap µF	DCR Max Ohms	CKT	Max L In (mm)	Thd Lgth	Minimum Insertion Loss (dB)						
		85°C		125°C								30	150	300	1	10	100	1
		DC	AC	DC	AC							KHz	KHz	KHz	MHz	MHz	MHz	GHz
† 9200-303-0095	— 1	80	—	50	—	10.00	1.200	0.010	LB	0.450 (11.430)	B	15	28	33	44	60	70	70
51-353-101	— 1	80	—	50	—	10.00	1.400	0.010	LT	0.450 (11.430)	A	14	28	33	44	60	70	70
51-353-109	— 1	80	—	50	—	10.00	1.400	0.010	LT	0.450 (11.430)	B	15	28	33	44	60	70	70
51-353-120	— 1	150	—	100	—	1.00	0.750	0.250	LB	0.758 (19.253)	A	9	27	36	57	70	70	70
9000-103-0019	— 1	150	—	100	—	5.00	0.450	0.015	LT	0.758 (19.253)	B	6	20	26	37	68	70	70
SCI-2120-014	— 1	150	—	100	—	10.00	1.000	0.003	LB	0.450 (11.430)	B	14	28	34	44	52	70	70
51-353-110	— 1	250	—	200	125	1.00	0.250	0.250	LT	0.758 (19.253)	A	—	17	29	50	70	70	70
51-353-112	— 1	250	—	200	125	3.00	0.250	0.050	LT	0.758 (19.253)	A	—	13	20	35	70	70	70
51-353-116	— 1	250	—	200	125	10.00	0.250	0.010	LT	0.450 (11.430)	A	—	15	20	30	50	70	70
SCI-2320-010	— 1	300	—	300	125	0.50	0.150	1.000	LB	0.758 (19.253)	B	—	23	35	56	70	70	70
SCI-2320-004	— 1	300	—	300	125	1.00	0.150	0.250	LB	0.758 (19.253)	A	—	10	21	41	70	70	70
SCI-2320-005	— 1	300	—	300	125	2.00	0.150	0.063	LB	0.758 (19.253)	A	—	8	14	30	70	70	70
SCI-2320-007	— 1	300	—	300	125	10.00	0.150	0.003	LB	0.450 (11.430)	A	—	8	14	25	45	52	70
SCI-2320-014	— 1	300	—	300	125	10.00	0.150	0.003	LB	0.450 (11.430)	B	—	8	14	25	45	52	70

.375 ø L Circuit MIL Qualified Profile

(See MIL index on pages CF9-11 for complete MIL part number listing)

Part Number	M15733 MIL No	See Pg. LP30 for Fig	Rated Voltage				I Amp	Min Cap µF	DCR Max Ohms	CKT	Max L In (mm)	Thd Lgth	Minimum Insertion Loss (dB)						
			85°C		125°C								30	150	300	1	10	100	1
			DC	AC	DC	AC							KHz	KHz	KHz	MHz	MHz	MHz	GHz
51-390-018	23-0026	1	—	—	50	—	0.50	1.400	0.360	LB	0.630 (16.002)	A	12	36	48	69	70	70	70
51-390-026	23-0038	1	—	—	50	—	1.00	1.400	0.140	LB	0.630 (16.002)	A	11	26	36	55	70	70	70
51-390-034	23-0050	1	—	—	50	—	2.00	1.400	0.070	LB	0.630 (16.002)	A	10	24	32	48	70	70	70
† 51-353-067	24-0006	1	80	—	50	—	10.00	1.400	0.010	LB	0.760 (19.304)	B	15	28	31	42	56	70	70
51-353-207	34-0007	1	—	—	50	—	10.00	1.400	0.010	LB	0.760 (19.304)	A	15	28	31	42	56	70	70
51-444-072	58-0002	1	80	—	50	—	10.00	1.400	0.008	LT	0.545 (13.843)	A	15	28	33	44	60	70	70
† 51-353-066	24-0005	1	80	—	50	—	10.00	1.400	0.010	LB	0.760 (19.304)	A	15	28	31	42	56	70	70
51-353-287	39-0014	1	—	—	50	—	10.00	1.400	0.003	LT	0.760 (19.304)	B	14	28	34	44	52	70	70
† 51-444-060	24-0008	1	80	—	50	—	10.00	1.400	0.010	LT	0.740 (18.796)	B	15	28	31	42	56	70	70
† 51-343-028	38-0002	1	—	—	50	—	15.00	1.400	0.008	LB	0.481 (12.217)	A	15	28	33	44	64	70	70
† 51-343-034	38-0006	1	—	—	50	—	15.00	1.400	0.008	LB	0.481 (12.217)	B	15	28	33	44	64	70	70
51-353-053	25-0003	1	—	—	100	—	1.00	0.450	0.250	LB	0.738 (18.745)	A	6	23	34	55	70	70	70
† 51-353-054	25-0005	1	—	—	100	—	5.00	0.450	0.015	LT	0.758 (19.253)	A	6	17	23	35	69	70	70
† 51-353-055	25-0008	1	—	—	100	—	5.00	0.450	0.015	LB	0.738 (18.745)	A	6	17	23	35	69	70	70
51-353-155	39-0008	1	—	—	100	—	5.00	0.450	0.015	LB	0.760 (19.304)	A	6	20	26	35	60	60	70
51-444-039	25-0017	1	—	—	100	—	5.00	0.450	0.015	LT	0.758 (19.253)	B	6	17	23	35	69	70	70

† Also available through authorized distributors.

Hermetically Sealed Threaded Case Filters

L-C Filter LT

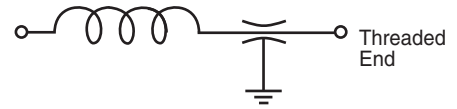

L-C Filter LB

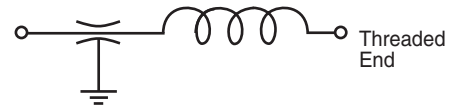

.375 ø L Circuit MIL Qualified Profile *continued*

(See MIL index on pages CF9-11 for complete MIL part number listing)

Part Number	M15733 MIL No	See Pg. LP30 for Fig	Rated Voltage				I Amp	Min Cap µF	DCR Max Ohms	CKT	Max L In (mm)	Thd Lgth	Minimum Insertion Loss (dB)							
			85°C		125°C								30 KHz	150 KHz	300 KHz	1 MHz	10 MHz	100 MHz	1 GHz	
			DC	AC	DC	AC														
51-444-040	25-0020	1	—	—	100		5.00	0.450	0.015	LB	0.738 (18.745)	B	6	17	23	35	69	70	70	
51-353-156	39-0009	1	—	—	100		10.00	0.450	0.003	LT	0.760 (19.304)	A	6	20	26	35	56	60	70	
51-353-157	39-0010	1	—	—	100		10.00	0.450	0.003	LB	0.760 (19.304)	A	6	20	26	35	56	60	70	
+ 51-353-076	26-0001	1	—	—	150	125	1.00	0.250	0.250	LT	0.758 (19.253)	A	—	13	24	45	80	70	70	
+ 51-353-077	26-0003	1	—	—	150	125	1.00	0.250	0.250	LB	0.738 (18.745)	A	—	13	24	45	80	70	70	
51-444-043	26-0013	1	—	—	150	125	1.00	0.250	0.250	LT	0.758 (19.253)	B	—	13	24	45	80	70	70	
51-444-044	26-0015	1	—	—	150	125	1.00	0.250	0.250	LB	0.738 (18.745)	B	—	13	24	45	80	70	70	
51-390-040	23-0058	1	—	—	150		2.00	0.250	0.070	LT	0.630 (16.002)	A	3	15	23	38	60	70	60	
51-390-039	23-0057	1	—	—	150		2.00	0.250	0.070	LT	0.630 (16.002)	B	3	15	23	38	60	70	60	
51-444-005	34-0015	1	—	—	150	125	3.00	0.150	0.050	LT	0.758 (19.253)	B	—	8	15	30	68	70	70	
+ 51-353-078	26-0004	1	—	—	150	125	3.00	0.250	0.050	LT	0.758 (19.253)	A	—	8	15	30	68	70	70	
+ 51-353-079	26-0006	1	—	—	150	125	3.00	0.250	0.050	LB	0.738 (18.745)	A	—	8	15	30	68	70	70	
+ 51-444-046	26-0018	1	—	—	150	125	3.00	0.250	0.050	LB	0.738 (18.745)	B	—	8	15	30	68	70	70	
51-444-047	26-0019	1	—	—	150	125	5.00	0.250	0.015	LT	0.758 (19.253)	B	—	8	14	25	58	70	70	
+ 51-353-080	26-0007	1	—	—	150	125	5.00	0.250	0.015	LT	0.758 (19.253)	A	—	8	14	25	58	70	70	
51-353-081	26-0010	1	—	—	150	125	5.00	0.250	0.015	LB	0.738 (18.745)	A	—	8	14	25	58	70	70	
51-444-027	34-0030	1	—	—	200	125	5.00	0.250	0.150	LB	0.900 (22.860)	A	2	15	21	32	60	70	70	
51-444-117	54-0018	2	—	—	300	125	1.00	0.150	0.250	LB	0.740 (18.796)	A	—	10	21	41	70	70	70	

† Also available through authorized distributors.

Hermetically Sealed Threaded Case Filters



.375 ø Pi Circuit

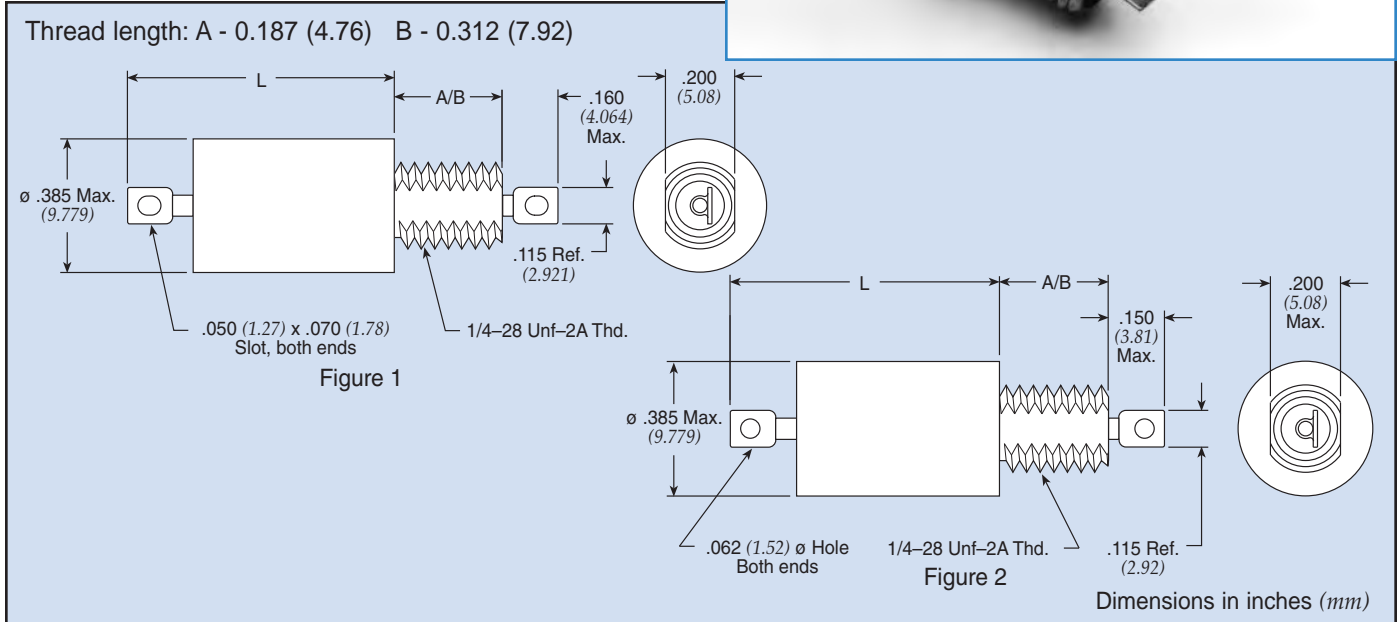

.375 ø Pi Circuit Standard Product

Part Number	MIL No	Figure	Rated Voltage				I Amp	Min Cap µF	DCR Max Ohms	Max In	Thd Lgth	Minimum Insertion Loss (dB)						
			85°C DC	85°C AC	125°C DC	125°C AC						30 KHz	150 KHz	300 KHz	1 MHz	10 MHz	100 MHz	1 GHz
SCI-2030-010	—	2	80	—	50	—	0.50	1.500	1.000	0.758 (19.253)	B	24	66	70	70	70	70	70
SCI-2030-005	—	2	80	—	50	—	2.00	1.500	0.063	0.758 (19.253)	A	—	45	62	70	70	70	70
SCI-2030-006	—	2	80	—	50	—	3.00	1.500	0.027	0.758 (19.253)	A	—	35	55	70	70	70	70
SCI-2030-013	—	2	80	—	50	—	3.00	1.500	0.027	0.758 (19.253)	B	—	35	55	70	70	70	70
†9001-100-1081	—	1	80	—	50	—	10.0	2.800	0.005	0.758 (19.253)	A	21	32	40	35	68	70	70
SCI-2130-009	—	1	150	—	100	—	0.25	1.000	4.000	0.758 (19.253)	B	28	70	70	70	70	70	70
51-311-319	—	1	150	—	100	—	0.50	1.000	0.600	0.758 (19.253)	A	—	51	69	70	70	70	70
†9001-100-1013	—	1	150	—	100	—	1.00	1.000	0.250	0.758 (19.253)	A	—	28	59	70	70	70	70
†51-311-322	—	1	150	—	100	—	5.00	1.000	0.015	0.758 (19.253)	A	—	—	28	65	70	70	70
SCI-2130-007	—	1	150	—	100	—	10.0	1.000	0.003	0.758 (19.253)	A	9	24	29	40	70	70	70
SCI-2130-014	—	1	150	—	100	—	10.0	1.000	0.005	0.758 (19.253)	B	9	24	29	40	70	70	70
51-311-316	—	1	250	125	200	125	1.00	0.300	0.250	0.758 (19.253)	A	—	20	40	70	70	70	70
51-311-317	—	1	250	125	200	125	3.00	0.300	0.050	0.758 (19.253)	A	—	—	20	55	70	70	70
†9001-100-1025	—	1	250	125	200	125	5.00	0.300	0.015	0.758 (19.253)	A	—	—	12	50	70	70	80
SCI-2330-009	—	1	300	125	300	125	0.25	0.300	4.000	0.758 (19.253)	B	8	50	66	70	70	70	70
SCI-2330-010	—	1	300	125	300	125	0.50	0.300	1.000	0.758 (19.253)	B	—	40	56	70	70	70	70
SCI-2330-012	—	1	300	125	300	125	2.00	0.300	0.063	0.758 (19.253)	B	—	18	33	63	70	70	70
SCI-2330-007	—	1	300	125	300	125	10.0	0.300	0.003	0.758 (19.253)	A	—	14	20	30	70	70	70

† Also available through authorized distributors.

Hermetically Sealed Threaded Case Filters

.375 ø Pi Circuit MIL Qualified Product

(See MIL index on pages CF9-11 for complete MIL part number listing)

Part Number	M15733 MIL No	See Pg. LP33 for Fig.	Rated Voltage				I Amp	Min Cap µF	DCR Max Ohms	Max L		Thd Lgth	Minimum Insertion Loss (dB)						
			85°C		125°C					In	(mm)		30 KHz	150 KHz	300 KHz	1 MHz	10 MHz	100 MHz	1 GHz
			DC	AC	DC	AC													
51-390-305	23-0017	1	—	—	50	—	0.30	2.800	0.770	0.730	(18.542)	B	29	73	80	80	80	80	
51-390-314	23-0042	1	—	—	50	—	1.00	2.800	0.140	0.730	(18.542)	A	8	52	71	80	80	80	80
† 51-390-318	23-0054	1	—	—	50	—	2.00	1.500	0.070	0.730	(18.542)	A	—	46	65	80	80	80	80
† 51-390-317	23-0053	1	—	—	50	—	2.00	1.500	0.070	0.730	(18.542)	B	—	46	65	80	80	80	80
51-311-311	25-0010	1	—	—	100	—	0.25	0.900	1.500	0.793	(20.142)	A	—	48	66	80	80	80	70
† 51-311-308	25-0002	1	—	—	100	—	1.00	0.500	0.250	0.793	(20.142)	A	—	33	52	80	80	80	70
† 51-311-309	25-0004	1	—	—	100	—	3.00	0.660	0.050	0.793	(20.142)	A	—	17	34	68	80	80	70
† 51-311-310	25-0006	1	—	—	100	—	5.00	0.900	0.015	0.793	(20.142)	A	—	—	17	57	80	80	70
51-353-344	39-0011	1	—	—	100	—	10.0	0.990	0.003	0.760	(19.304)	A	9	24	29	40	70	70	70
51-353-345	39-0012	1	—	—	100	—	10.0	0.990	0.003	0.760	(19.304)	A	9	24	29	40	70	70	70
† 51-311-314	26-0011	1	—	—	150	125	0.25	0.300	1.500	0.793	(20.142)	A	—	29	47	70	80	80	70
51-390-312	23-0036	1	—	—	150	—	0.50	0.500	0.360	0.730	(18.542)	A	—	48	66	70	70	70	70
51-390-311	23-0035	1	—	—	150	—	0.50	0.500	0.360	0.730	(18.542)	B	—	48	66	70	70	70	70
† 51-353-336	26-0002	1	—	—	150	125	1.00	0.300	0.250	0.793	(20.142)	A	—	11	32	63	80	80	70
51-390-315	23-0047	1	—	—	150	—	1.00	0.500	0.140	0.730	(18.542)	B	—	32	51	70	70	70	70
51-311-312	26-0005	1	—	—	150	125	3.00	0.300	0.050	0.793	(20.142)	A	—	5	6	47	80	80	70
51-311-408	54-0005	2	—	—	300	115	1.00	0.300	0.250	0.761	(19.329)	A	—	23	43	70	70	70	70

† Also available through authorized distributors.

Transient Suppression Pi Filters

Part Number	Volt VDC	I Amp	Min Cap µF	DCR Min mOhm	Max RDC Ohm	Transient Suppressor*				Minimum Insertion Loss (dB)					
						VR VDC	BV VDC	IT MA	IPP A	30 KHz	300 KHz	1 MHz	10 MHz	100 MHz	1 GHz
51-570-310	28	0.5	1.4	30.0	0.600	33.0	36.7/40.6	1	9.4	23	57	70	70	70	70
51-570-324	50	10.0	1.4	50.0	0.005	58.0	64.4/71.2	1	5.3	16	26	35	40	40	70

* Transient Suppression definitions and ratings

VR = Reverse standoff voltage
BV = Breakdown voltage

IPP = Max. peak pulse current
IT = Test current

Hermetically Sealed Threaded Case Filters



.375 ø T Circuit

Thread length: A - 0.187 (4.76) B - 0.312 (7.92)

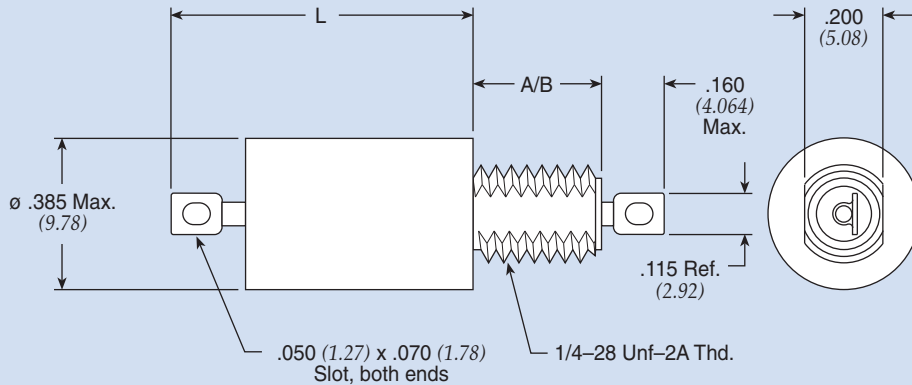

Figure 1

Note: Max. O.D. is ø .416" for Military QPL Filters.

Dimensions in inches (mm)

.375 ø T Circuit Standard Product

Part Number	MIL No	Figure	Rated Voltage				I Amp	Min Cap µF	DCR Max Ohms	Max L In (mm)	Thd Lgth	Minimum Insertion Loss (dB)						
			85°C		125°C							30 KHz	150 KHz	300 KHz	1 MHz	10 MHz	100 MHz	1 GHz
SCI-2040-012	—	1	80	—	50	—	2.00	1.400	0.126	1.071 (27.203)	B	8	22	30	55	70	70	70
SCI-2040-013	—	1	80	—	50	—	3.00	1.400	0.054	1.071 (27.203)	B	8	22	28	43	70	70	70
+9004-100-2017	—	1	80	—	50	—	15.0	1.400	0.005	1.179 (29.947)	A	17	27	34	44	60	70	70
SCI-2140-004	—	1	150	—	100	—	1.00	0.500	0.500	1.070 (27.178)	A	4	25	40	70	70	70	70
SCI-2140-006	—	1	150	—	100	—	3.00	0.500	0.054	1.071 (27.203)	A	4	19	24	39	70	70	70
SCI-2140-007	—	1	150	—	100	—	10.0	0.500	0.010	1.071 (27.203)	A	4	19	24	34	57	70	70
SCI-2340-009	—	1	300	—	300	125	0.25	0.150	8.000	1.071 (27.203)	B	11	57	70	70	70	70	70
SCI-2340-004	—	1	300	—	300	125	1.00	0.150	0.500	1.071 (27.203)	A	—	13	29	59	70	70	70
SCI-2340-013	—	1	300	—	300	125	3.00	0.150	0.054	1.071 (27.203)	B	—	8	14	29	70	70	70
SCI-2340-014	—	1	300	—	300	125	10.0	0.150	0.010	1.071 (27.203)	B	—	8	14	24	47	70	70

+ Also available through authorized distributors.

(See MIL index on pages CF9-11 for complete MIL part number listing)

.375 ø T Circuit MIL Qualified Product

Part Number	M15733 MIL No	Figure	Rated Voltage				I Amp	Min Cap µF	DCR Max Ohms	Max L In (mm)	Thd Lgth	Minimum Insertion Loss (dB)						
			85°C		125°C							30 KHz	150 KHz	300 KHz	1 MHz	10 MHz	100 MHz	1 GHz
51-382-609	25-0024	1	—	—	100	—	2.00	0.750	0.100	1.179 (29.947)	B	10	22	31	55	80	70	70
51-382-603	25-0007	1	—	—	100	—	4.00	0.750	0.063	1.345 (34.163)	A	10	22	28	43	80	70	70
+51-351-604	26-0012	1	—	—	150	125	2.00	0.250	0.100	1.179 (29.947)	A	—	13	21	43	80	70	70
51-351-603	26-0008	1	—	—	150	125	4.00	0.250	0.063	1.345 (34.163)	A	—	11	18	33	80	70	70

+ Also available through authorized distributors.

Hermetically Sealed Threaded Case Filters

.375 ø TT Circuit Standard Product

Part Number	MIL No	See Pg. LP35 for Fig.	Rated Voltage				I Amp	Min Cap μ F	DCR Max Ohms	Max L		Thd Lgth	Minimum Insertion Loss (dB)						
			85°C		125°C					In	(mm)		30 KHz	150 KHz	300 KHz	1 MHz	10 MHz	100 MHz	1 GHz
			DC	AC	DC	AC													
SCI-2060-009	—	1	—	—	50	—	0.25	1.500	12.000	1.241	(31.521)	B	70	70	70	70	70	70	70
SCI-2060-013	—	1	—	—	50	—	3.00	1.500	0.081	1.241	(31.521)	B	—	33	54	70	70	70	70
SCI-2060-007	—	1	—	—	50	—	10.0	1.500	0.006	1.241	(31.521)	A	15	29	35	42	55	70	70
SCI-2060-014	—	1	—	—	50	—	10.0	1.500	0.006	1.241	(31.521)	B	15	29	35	42	55	70	70
SCI-2160-011	—	1	—	—	100	—	1.00	1.500	0.750	1.241	(31.521)	B	12	52	70	70	70	70	70
SCI-2160-012	—	1	—	—	100	—	2.00	1.500	0.189	1.241	(31.521)	B	—	33	56	70	70	70	70
SCI-2160-013	—	1	—	—	100	—	3.00	1.500	0.081	1.241	(31.521)	B	—	24	54	70	70	70	70
SCI-2160-014	—	1	—	—	100	—	10.0	1.400	0.006	1.241	(31.521)	B	12	25	32	42	70	70	70
SCI-2360-011	—	1	—	—	300	125	1.00	0.500	0.750	1.241	(31.521)	B	—	48	70	70	70	70	70
SCI-2360-006	—	1	—	—	300	125	3.00	0.500	0.080	1.241	(31.521)	A	—	12	38	70	70	70	70
SCI-2360-007	—	1	—	—	300	125	10.0	0.500	0.006	1.241	(31.521)	A	5	18	24	34	55	70	70
SCI-2360-014	—	1	—	—	300	125	10.0	0.500	0.006	1.241	(31.521)	B	5	18	24	34	55	70	70

Hermetically Sealed Threaded Case Filters



.690 ø C Circuit

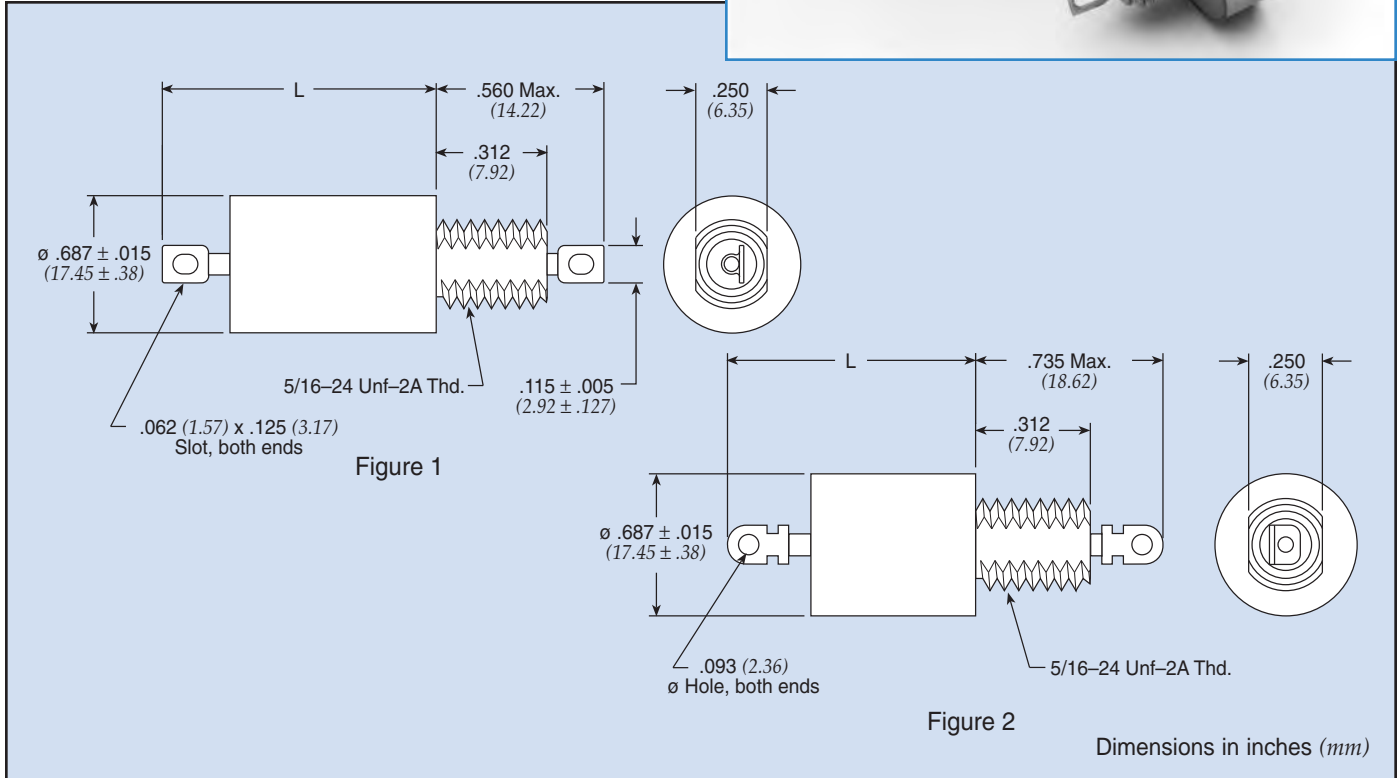

.690 ø C Circuit Standard Product

Part Number	MIL No	Figure	Rated Voltage				I Amp	Min Cap μ F	DCR Max Ohms	Max L		Minimum Insertion Loss (dB)						
			85°C		125°C					In	L (mm)	30 KHz	150 KHz	300 KHz	1 MHz	10 MHz	100 MHz	1 GHz
			DC	AC	DC	AC												
† 9932-100-6004	—	1	200	—	150	125	15	2.600	0.005	0.702	(17.831)	10	29	39	50	60	70	70
54-310-001	—	1	300	—	300	125	15	0.500	0.005	0.560	(14.224)	6	19	25	36	50	70	70
54-310-005	—	2	250	—	200	125	25	0.500	0.005	0.750	(19.050)	6	19	25	36	50	70	70
54-310-009	—	1	450	240	400	240	15	0.250	0.005	0.560	(14.224)	—	14	19	30	45	60	70
† 9932-100-6005	—	1	450	240	400	240	15	0.250	0.005	0.560	(14.224)	—	14	19	30	50	70	70

.690 ø C Circuit MIL Qualified Product

Part Number	M15733 MIL No	Figure	Rated Voltage				I Amp	Min Cap μ F	DCR Max Ohms	Max L		Minimum Insertion Loss (dB)						
			85°C		125°C					In	L (mm)	30 KHz	150 KHz	300 KHz	1 MHz	10 MHz	100 MHz	1 GHz
			DC	AC	DC	AC												
54-310-039	34-0037	1	—	—	275	125	15	0.200	0.005	0.575	(14.605)	5	15	21	31	51	70	70

.690 ø C Circuit DSCC 84084 Product

Part Number	84084 No	Figure	Rated Voltage				I Amp	Min Cap μ F	DCR Max Ohms	Max L		Minimum Insertion Loss (dB)						
			85°C		125°C					In	L (mm)	30 KHz	150 KHz	300 KHz	1 MHz	10 MHz	100 MHz	1 GHz
			DC	AC	DC	AC												
54-310-042	-001	1	—	—	400	230	15	0.150	0.005	0.700	(17.780)	—	10	16	26	40	52	70

† Also available through authorized distributors.

Hermetically Sealed Threaded Case Filters



.690 ø L Circuit

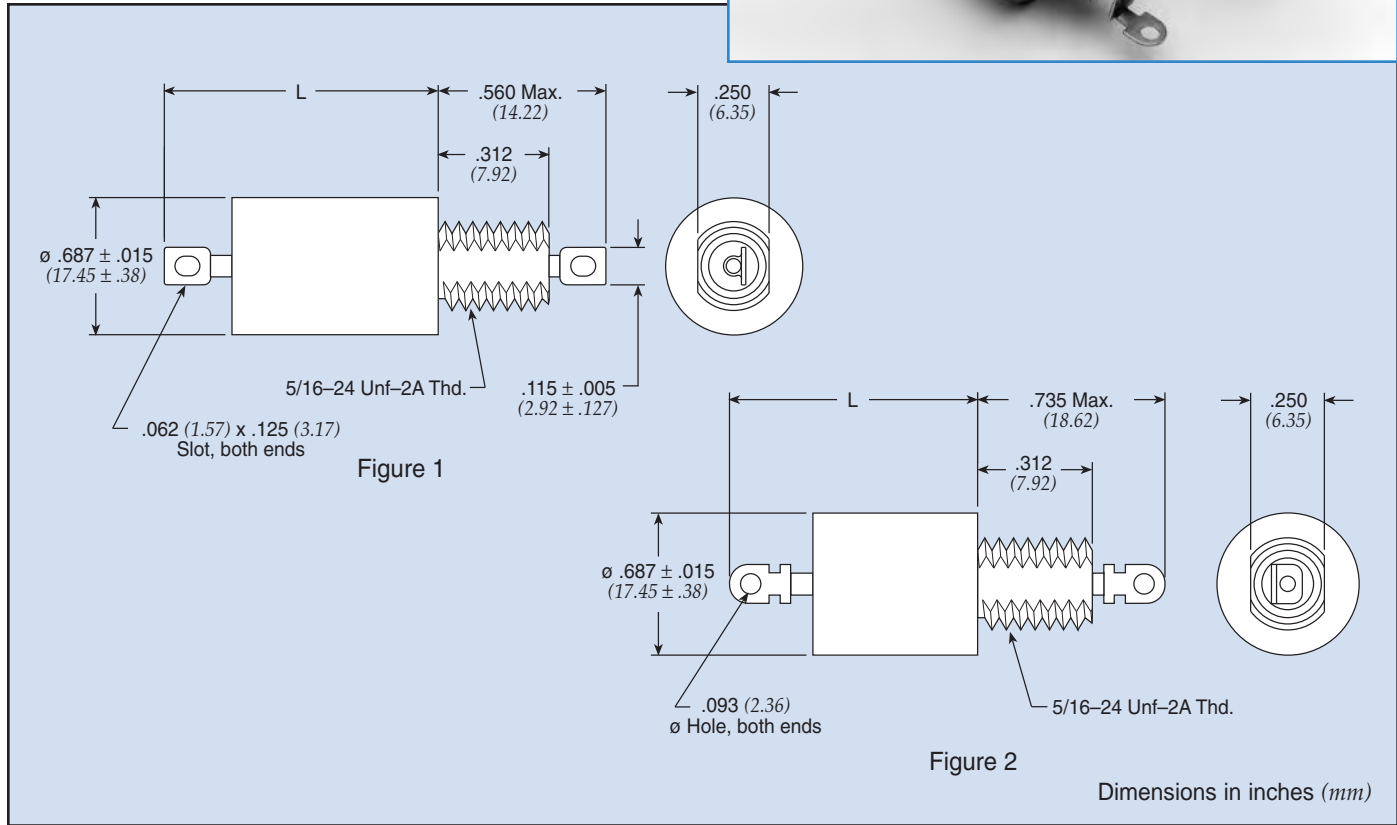

.690 ø L Circuit Standard Product

Part Number	MIL No	Figure	Rated Voltage				I Amp	Min Cap μ F	DCR Max Ohms	CKT	Max L		Minimum Insertion Loss (dB)						
			85°C		125°C						In	L (mm)	30 KHz	150 KHz	300 KHz	1 MHz	10 MHz	100 MHz	1 GHz
9010-100-0049	—	1	150	—	100	—	10.0	1.400	0.005	LT	0.905	(22.987)	16	24	34	44	60	70	70
SCI-6120-008	—	1	150	—	100	—	10.0	2.600	0.006	LB	0.959	(24.359)	18	32	39	49	70	70	70
SCI-6120-009	—	1	150	—	100	—	20.0	2.600	0.001	LB	0.560	(22.987)	18	32	39	49	60	70	70
51-320-041	—	1	250	—	200	125	10.0	0.500	0.008	LT	0.905	(22.987)	5	19	25	35	50	70	70
51-320-024	—	1	450	240	400	240	1.00	0.360	0.210	LT	0.905	(22.987)	5	30	38	60	70	70	70
51-320-100	—	1	450	240	400	240	1.00	0.250	0.210	LT	0.905	(22.987)	—	21	33	55	70	70	70
† 51-320-026	—	1	450	240	400	240	3.00	0.360	0.030	LT	0.905	(22.987)	5	19	25	45	70	70	70
51-320-103	—	1	450	240	400	240	5.00	0.360	0.010	LB	0.905	(22.987)	—	12	18	30	60	70	70
51-322-007	—	1	450	240	400	240	15.0	0.360	0.007	LB	0.650	(16.510)	5	19	25	35	48	62	70
51-322-015	—	2	450	240	400	240	25.0	0.360	0.007	LT	0.750	(19.050)	5	17	23	34	48	62	70
51-322-036	—	2	450	240	400	240	25.0	0.250	0.007	LB	0.750	(19.050)	—	10	16	29	45	60	70
9010-100-0054	—	1	450	240	300	240	1.00	0.150	0.250	LT	0.905	(22.987)	—	14	32	52	70	70	70
SCI-6320-004	—	1	300	—	300	125	1.00	0.400	0.300	LB	0.959	(24.359)	6	24	35	56	70	70	70

† Also available through authorized distributors.

Hermetically Sealed Threaded Case Filters

L-C Filter LT

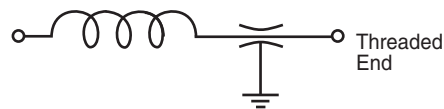

L-C Filter LB

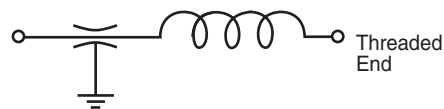

(See MIL index on pages CF9-11 for complete MIL part number listing)

.690 ø L Circuit MIL Qualified Product

Part Number	M15733 MIL No	See Pg. LP38 for Fig.	Rated Voltage				I Amp	Min Cap μ F	DCR Max Ohms	CKT	Max L In	Max L (mm)	Minimum Insertion Loss (dB)							
			85°C		125°C								30 KHz	150 KHz	300 KHz	1 MHz	10 MHz	100 MHz	1 GHz	
			DC	AC	DC	AC														
† 51-320-015	27-0005	1	—	—	200	125	3.00	0.250	0.033	LT	0.900	(22.860)	—	14	21	39	80	70	70	
51-320-017	27-0008	1	—	—	200	125	5.00	0.250	0.016	LT	0.900	(22.860)	—	13	19	32	69	70	70	
51-320-018	27-0009	1	—	—	200	125	5.00	0.250	0.016	LB	0.900	(22.860)	—	13	19	32	69	70	70	
51-323-003	27-0011	1	—	—	200	125	10.0	0.250	0.005	LT	1.031	(26.187)	—	13	19	30	61	70	70	
51-323-004	27-0012	1	—	—	200	125	10.0	0.250	0.005	LB	1.031	(26.187)	—	13	19	30	61	70	70	
† 51-322-009	27-0014	2	—	—	200	125	15.0	0.250	0.007	LT	1.763	(44.780)	—	19	25	36	60	70	70	
51-322-017	34-0002	2	—	—	200	125	20.0	0.360	0.050	LB	1.763	(44.780)	—	19	25	35	57	70	70	

.690 ø L Circuit DSCC 84084 Product

Part Number	84084 No	See Pg. LP38 for Fig.	Rated Voltage				I Amp	Min Cap μ F	DCR Max Ohms	CKT	Max L In	Max L (mm)	Minimum Insertion Loss (dB)							
			85°C		125°C								30 KHz	150 KHz	300 KHz	1 MHz	10 MHz	100 MHz	1 GHz	
			DC	AC	DC	AC														
51-320-162	-004	1	—	—	400	230	1.00	0.150	0.150	LT	0.905	(22.987)	—	19	30	46	60	70	70	
51-320-163	-005	1	—	—	400	230	1.00	0.150	0.150	LB	0.905	(22.987)	—	19	30	46	60	70	70	
51-320-164	-006	1	—	—	400	230	3.00	0.150	0.026	LT	0.905	(22.987)	—	11	19	36	60	70	70	
51-320-165	-007	1	—	—	400	230	3.00	0.150	0.026	LB	0.905	(22.987)	—	11	19	36	60	70	70	
51-320-166	-008	1	—	—	400	230	5.00	0.150	0.013	LT	0.905	(22.987)	—	10	16	28	54	70	70	
51-320-167	-009	1	—	—	400	230	5.00	0.150	0.013	LB	0.905	(22.987)	—	10	16	28	54	70	70	
51-320-168	-010	1	—	—	400	230	10.0	0.150	0.008	LT	0.905	(22.987)	—	10	16	25	48	70	70	
51-320-169	-011	1	—	—	400	230	10.0	0.150	0.008	LB	0.905	(22.987)	—	10	16	25	48	70	70	

† Also available through authorized distributors.

Hermetically Sealed Threaded Case Filters

.690 ø Pi Circuit

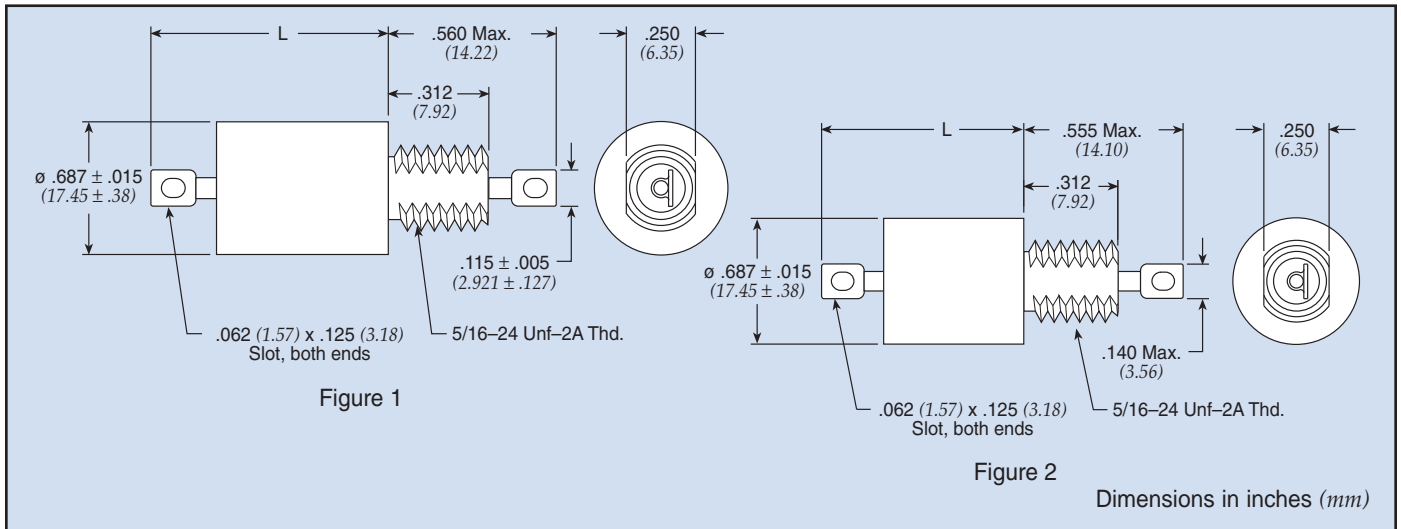

.690 ø Pi Circuit Standard Product

Part Number	MIL No	Figure	Rated Voltage				I Amp	Min Cap μ F	DCR Max Ohms	Max L (mm)		Minimum Insertion Loss (dB)						
			85°C		125°C							30 KHz	150 KHz	300 KHz	1 MHz	10 MHz	100 MHz	1 GHz
			DC	AC	DC	AC						In	L					
51-321-322	—	1	150	—	100	—	1.00	2.800	0.210	1.195	(30.353)	35	69	70	70	70	70	70
SCI-6130-009	—	1	150	—	100	—	20.0	5.200	0.001	1.195	(30.353)	23	31	35	35	70	70	70
51-321-317	—	1	450	240	400	*240	1.00	0.720	0.400	1.195	(30.353)	—	53	70	70	70	70	70
†51-321-318	—	1	450	240	400	*240	3.00	0.720	0.030	1.195	(30.353)	—	31	51	70	70	70	70
†51-321-319	—	1	450	240	400	*240	5.00	0.720	0.020	1.195	(30.353)	—	11	30	65	70	70	70

* 0-60 Hz

.690 ø Pi Circuit MIL Qualified Product

(See MIL index on pages CF8-10 for complete MIL part number listing)

Part Number	M15733 MIL No	Figure	Rated Voltage				I Amp	Min Cap μ F	DCR Max Ohms	Max L (mm)		Minimum Insertion Loss (dB)						
			85°C		125°C							30 KHz	150 KHz	300 KHz	1 MHz	10 MHz	100 MHz	1 GHz
			DC	AC	DC	AC						In	L					
51-321-312	27-0004	1	—	—	200	125	1.00	0.500	0.250	1.195	(30.353)	—	47	65	80	80	70	70
51-323-313	27-0003	1	—	—	200	125	1.00	0.500	0.270	1.031	(26.187)	—	43	61	80	80	70	70
51-321-313	27-0010	1	—	—	200	125	5.00	0.500	0.024	1.195	(30.353)	—	10	28	64	80	70	70
†51-321-314	27-0013	1	—	—	200	125	10.0	0.500	0.008	1.195	(30.353)	—	16	18	48	80	70	70
51-321-329	34-0005	1	—	—	200	125	10.0	0.500	0.075	1.195	(30.353)	—	16	18	48	80	70	70

.690 ø Pi Circuit DSCC 84084 Product

Part Number	84084 No	Figure	Rated Voltage				I Amp	Min Cap μ F	DCR Max Ohms	Max L (mm)		Minimum Insertion Loss (dB)						
			85°C		125°C							30 KHz	150 KHz	300 KHz	1 MHz	10 MHz	100 MHz	1 GHz
			DC	AC	DC	AC						In	L					
51-321-398	-013	2	—	—	400	230	1.00	0.200	0.150	1.200	(30.480)	—	27	46	74	80	80	80
51-321-399	-014	2	—	—	400	230	3.00	0.200	0.026	1.200	(30.480)	—	—	30	60	80	80	80
51-321-400	-015	2	—	—	400	230	5.00	0.200	0.013	1.200	(30.480)	—	—	12	50	80	80	80
51-321-401	-016	2	—	—	400	230	10.0	0.200	0.008	1.200	(30.480)	—	—	—	30	80	80	80

† Also available through authorized distributors.

Hermetically Sealed Threaded Case Filters

.690 ø T Circuit

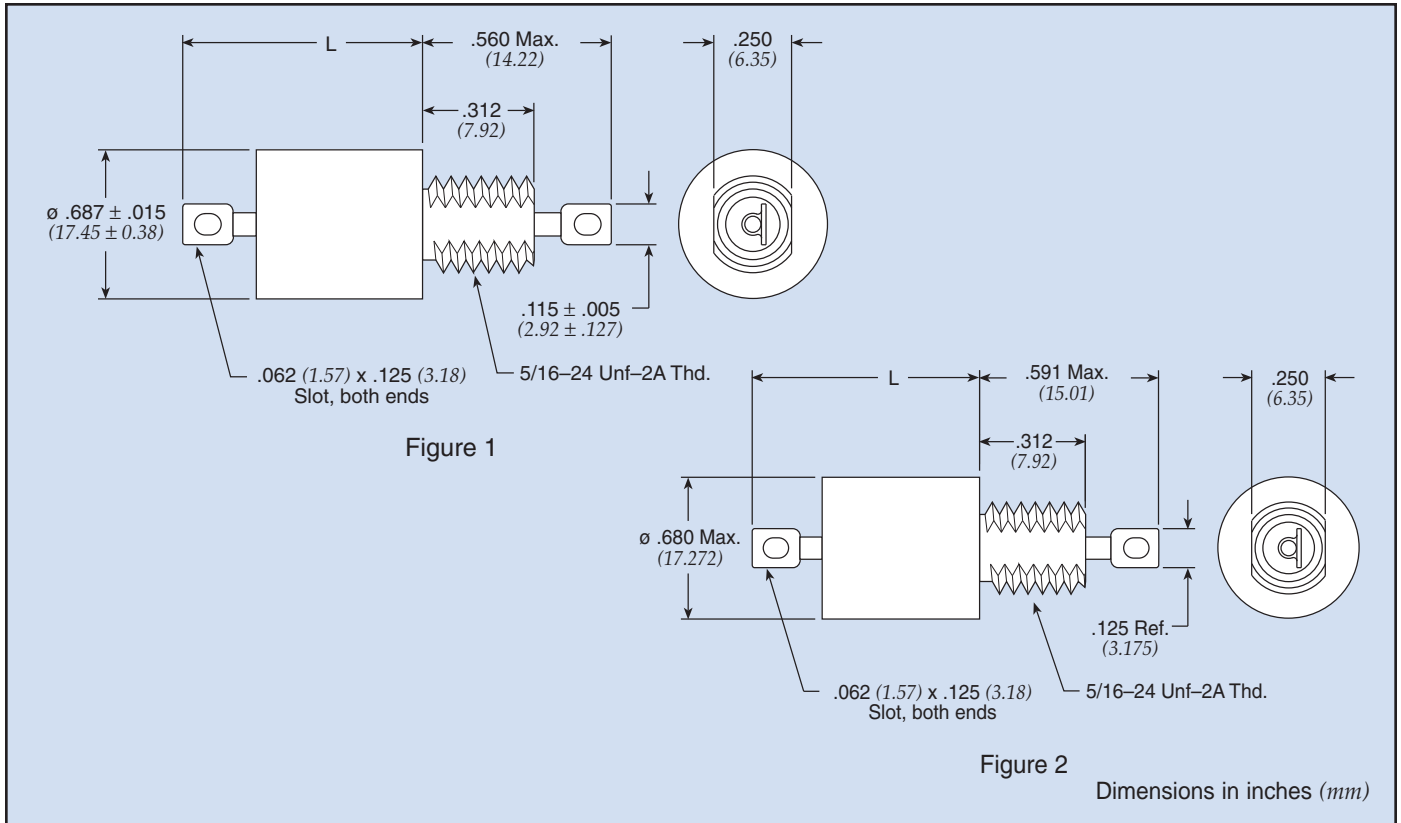

.690 ø T Circuit Standard Product

Part Number	MIL No	Figure	Rated Voltage				I Amp	Min Cap μ F	DCR Max Ohms	Max L (mm)		Minimum Insertion Loss (dB)						
			85°C		125°C							30 KHz	150 KHz	300 KHz	1 MHz	10 MHz	100 MHz	1 GHz
			DC	AC	DC	AC						In						
SCI-6140-004	—	1	150	—	100	—	1.00	2.600	0.600	1.195	(30.353)	23	54	70	70	70	70	70
SCI-6140-006	—	1	150	—	100	—	3.00	2.600	0.100	1.195	(30.353)	21	35	46	70	70	70	70
SCI-6140-007	—	1	150	—	100	—	5.00	2.600	0.060	1.195	(30.353)	21	34	41	58	70	70	70
SCI-6140-009	—	1	150	—	100	—	20.0	2.600	0.002	1.195	(30.353)	21	35	41	50	60	70	70
51-321-649	—	1	250	125	200	125	2.00	0.360	0.090	1.195	(30.353)	—	24	38	65	70	70	70
† 51-321-610	—	1	450	240	400	240	1.00	0.360	0.600	1.195	(30.353)	7	43	60	70	70	70	70

.690 ø T Circuit MIL Qualified Product

(See MIL index on pages CF8-10 for complete MIL part number listing)

Part Number	M15733 MIL No	Figure	Rated Voltage				I Amp	Min Cap μ F	DCR Max Ohms	Max L (mm)		Minimum Insertion Loss (dB)						
			85°C		125°C							30 KHz	150 KHz	300 KHz	1 MHz	10 MHz	100 MHz	1 GHz
			DC	AC	DC	AC						In						
51-321-607	27-0017	1	—	—	200	125	1.50	0.250	0.133	1.195	(30.353)	—	19	32	62	70	70	70
51-321-608	27-0018	1	—	—	200	125	4.00	0.250	0.025	1.195	(30.353)	—	14	21	36	70	70	70
51-321-670	54-0017	2	—	—	300	115	10.0	0.500	0.006	1.177	(29.896)	5	20	23	35	60	70	60

† Also available through authorized distributors.